



FIRE PROTECTION CURTAIN type: **MARC-Ok EI120** with a VIC-type electric internal drive

THANK YOU FOR YOUR TRUST AND FOR PURCHASING THE PRODUCTS FROM „MAŁKOWSKI-MARTECH” S.A.



 MAŁKOWSKI MARTECH Czołowo, ul. Leśna 57, 62-035 Kórnik tel. +48 61 222 75 00 fax: +48 61 222 75 01 email: biuro@malkowski.pl, www.malkowski.pl	FIRE PROTECTION CURTAIN type: MARC-Ok E120	Ref. no.: ISOiK_Ok-1
	USE, OPERATION AND MAINTENANCE MANUAL	Revision: 12 / 2021

TABLE OF CONTENT

1. INTRODUCTION	3
2. APPLICATION SCOPE AND PREREQUISITES	4
2.1 INTENDED USE	4
2.2 NON-INTENDED USE	4
2.3 OHS RECOMMENDATIONS.....	6
2.4 SERVICE PERSONNEL REQUIREMENTS.....	6
3. PACKAGING, STORAGE, AND TRANSPORT	6
4. ASSEMBLY AND INSTALLATION	7
4.1 MECHANICAL INSTALLATION	7
4.2 ELECTRICAL INSTALLATION	7
5. OPERATING PRINCIPLE OF THE ELECTRICAL ACCESSORIES KIT	8
6. TECHNICAL SPECIFICATIONS	8
6.1 CURTAIN SHEET.....	13
6.2 WINDING SHAFT	14
6.3 SHAFT SUPPORT	15
6.4 GUIDE RAIL.....	16
6.5 COVER ASSEMBLY	18
6.6 ELECTRICAL ACCESSORIES KIT - VIC-0403	19
6.7 VIC-012x ELECTRICAL ACCESSORIES KIT.....	20
6.8 VIC-042x ELECTRICAL ACCESSORIES KIT.....	21
6.9 VIC-042x ELECTRICAL ACCESSORIES KIT.....	22
7. TROUBLESHOOTING	23
8. INSPECTION, MAINTENANCE, AND REPAIRS	23
8.1 INSPECTION & MAINTENANCE SCHEDULE.....	23
8.2 OPERATOR'S INSPECTIONS	25
8.3 SERVICE INSPECTIONS & MAINTENANCE	25
8.4 CLEANING.....	25
8.5 REPLACEMENT PARTS	25
9. DISPOSAL	26
9.1 CHEMICAL NOTICE	26
10. MARKING	27
11. APPENDICES	27



 MAŁKOWSKI MARTECH Czołowo, ul. Leśna 57, 62-035 Kórnik tel. +48 61 222 75 00 fax: +48 61 222 75 01 email: biuro@malkowski.pl, www.malkowski.pl	FIRE PROTECTION CURTAIN type: MARC-Ok E120	Ref. no.: ISOiK_Ok-1
	USE, OPERATION AND MAINTENANCE MANUAL	Revision: 12 / 2021

1. INTRODUCTION

This Manual of the fire protection curtain type MARC-Ok E120 (hereafter referred to as the device / fire door / roll up door), is a document containing data and instructions for the owner (user) necessary to familiarise themselves with its functioning, use, operation and maintenance. To ensure long-term, safe use of the product, the user and operating personnel shall fully understand and comply with this Manual.

The use of the product, including its operation, maintenance, servicing, periodic inspection, parts replacement, and repairs shall conform to this Manual.

Keep the Manual and other technical documentation appended to it safe and available to the operators and service technicians.

We reserve the right to continuous verification of the Manual contents and their adaptation to the state of the art. We hope the user understands that the Manual contents can be modified without prior notice. Some of the figures and narrative of this Manual may vary from the actual product, and if so, it is due to continuous improvement necessary due to changes in regulations of law and similar reasons; these variations do not affect the recommendations for use applicable to the product.

If this Manual is lost or damaged, contact our Customer Service and order the same version of the document.

CAUTION!

Failure in compliance with the recommendations and guidelines contained in this Manual will release the manufacturer from all liability and warranty obligations.

The servicing intended to be done by the service technicians and the user is specified further in this Manual. Only the manufacturer's authorized service may attempt assembly, installation, adjustment, parts replacement, repairs, and troubleshooting of this product.

This Manual applies to the standard accessories of the fire protection curtain; the application of optional accessories, if any, is specified in the sales contract for the product.

The roll-up fire door shall be used according to the engineering design developed for the intended installation location, and with consideration of the following:

- The prevailing construction and engineering standards and regulations, of which the particular ones apply:
 - a) Regulation of the European Parliament and of the Council (EU) No. 305/2011 of 9 March 2011 (CPR) laying down harmonised conditions for the marketing of construction products and repealing Council Directive 89/106/EEC (OJ L. EU L88 of 04.04.2011, as amended),
 - b) Act of 16 April 2004 on construction products (Dz.U. of 2020 item 215),
 - c) Building Law Act of 07 July 1994 (Dz.U. of 2020 item 1333),
 - d) Act of 13 April 2016 on the conformity and market surveillance system (Dz.U. of 2019 item 554),
 - e) Act of 24 August 1991 on fire protection (Dz.U. of 2020 item 961, 1610),
 - f) Regulation of the Minister of Infrastructure and Construction of 17 November 2016 and concerning the practice of declaration of performance for and construction mark labelling of construction products (Dz.U. of 2016 item 1966),
 - g) Regulation of the Minister of the Interior and Administration dated 7 June 2010 and concerning the fire protection of buildings, structures, and land (Dz.U. of 2010 item 109, 719, as amended),
 - h) Polish Regulation of the Minister of Infrastructure dated 12 April 2002 and concerning the technical requirements for buildings and locations thereof (Dz.U of 2019 item 1065),
 - i) EN 16034:2014-11 (Harmonised standard), Pedestrian doorsets, industrial, commercial, garage doors and openable windows – Product standard, performance characteristics – Fire resisting and/or smoke control characteristics;
 - j) PN-EN 13501-2:2016-07, Fire classification of construction products and building elements — Part 2:



 MAŁKOWSKI MARTECH Czołowo, ul. Leśna 57, 62-035 Kórnik tel. +48 61 222 75 00 fax: +48 61 222 75 01 email: biuro@malkowski.pl, www.malkowski.pl	FIRE PROTECTION CURTAIN type: MARC-Ok EI120	Ref. no.: ISOiK_Ok-1
	USE, OPERATION AND MAINTENANCE MANUAL	Revision: 12 / 2021

- Classification using data from fire resistance tests, excluding ventilation services,
- k) EN 13241+A2:2016-10 B (Harmonised standard) Industrial, commercial, garage doors and gates – Product standard, performance characteristics,
 - l) PN-EN 12635+A1:2010, Industrial, commercial and garage doors and gates – Installation and use,
 - m) PN-EN 12424:2002 Industrial, commercial and garage doors and gates – Resistance to wind load – Classification;
- The Declaration of Performance;
 - this Use, Operation and Maintenance Manual.

Pursuant to the EN standard (i) and the Regulation (f), the fire door is a construction product eligible for System 1 of Assessment and Verification of Constancy of Performance. Based on the Regulation (a), the manufacturer who markets a construction product is required to issue its Declaration of Performance (DoP) and apply a legible CE marking label to the product.

CAUTION!

A copy of the Declaration of Performance and the Warranty Certificate are provided by the manufacturer to the user after the acceptance of the installation/assembly of the fire door, in accordance with the sales contract (and/or the quotation).

A copy of the Declaration of Performance and the Warranty Certificate for the fire protection curtain is an integral part of this Manual and shown as its Appendices, ref. Section 11 APPENDICES.

The CE marking of the fire door is placed on its nameplate, ref. Section 10 IDENTIFICATION.

The valid list of authorized providers of product installation, service inspections, and maintenance (complete with assessment and certification of proper performance of these services) is available on the official website of the fire door manufacturer (www.malkowski.pl).

2. APPLICATION SCOPE AND PREREQUISITES

2.1 INTENDED USE

Type MARC-Ok EI120 fire protection curtain is a vertical, moving fire partition intended as the closure of a passageway between fire partitioned zones inside of industrial buildings, warehouse rooms, technical access floors in office buildings, hospitals, and other public buildings. It can also be used as a window fabric, mounted both externally and internally on window and door openings, designed to protect the interior of the aforementioned types of buildings.

If the door/curtain is used on the outside of the building, an additional drip edge and roof seal system are required to protect the inside of the cassette from the weather.

The operating temperature range of the door/curtain is -20°C to +40°C, whereby it may be difficult to carry out tests, trials and inspections at the minimum temperature in the range (does not apply to fire alarm situations).

The fire protection curtain/window curtain type MARC-Ok in its basic version is manufactured with a declared use category C0 (number of cycles 1 - 499, according to EN 16034:2014-11) and a wind load resistance class 1 (according to PN-EN 12424:2002) or **2** in the case of a curtain door/window curtain installed on the outside of the building – provided that the manufacturer has been informed in writing of this intention of use.

On request, the MARC-Ok EI120 protection curtain/window curtain can be manufactured with a declared use category **1** (number of cycles 500 - 9,999) or **2** (10,000 - 49,999) and wind load resistance class **2**.

2.2 NON-INTENDED USE

Type MARC- Ok EI120 fire protection curtain is not intended for the following applications:

- In Ex-zones (explosion hazard areas), unless qualified as intended for the application following suitable modifications by the manufacturer;
- In environmental conditions with presence of salinity, salts, acids, alkali, and/or other aggressive chemical (including cement and lime) which trigger corrosion (the maximum permitted relative humidity is 80%



 MAŁKOWSKI MARTECH Czołowo, ul. Leśna 57, 62-035 Kórnik tel. +48 61 222 75 00 fax: +48 61 222 75 01 email: biuro@malkowski.pl, www.malkowski.pl	FIRE PROTECTION CURTAIN type: MARC-Ok EI120	Ref. no.: ISOiK_Ok-1
	USE, OPERATION AND MAINTENANCE MANUAL	Revision: 12 / 2021

for this product);

- When exposed to strong electromagnetic fields (> 0.1 T);
- In areas with wind exposure with a force higher than the wind load resistance class stated on the nameplate and a copy of the Declaration of Performance.

CAUTION!

The PN-EN 12424:2002 wind load resistance has been determined for the closed product. Operation of the product in high winds can be hazardous!

Never attempt to:

- have the fire protection curtain assembled by a contractor who has not been authorized by the product manufacturer;
- repair, troubleshoot, improve, alter, modify, or replace or retrofit components or parts outside of the specification limits shown in this Manual and/or without a prior written authorization from the fire door manufacturer (ref. the manufacturer's authorization matrix in Section 6 TECHNICAL SPECIFICATION),
- install any parts or components which are non-genuine or non-original or not specified and/or authorized by the fire door manufacturer;
- operate the fire door which is defective, out of order or partially or wholly incompatible with the specified properties or intended use (due to damage from fire, a building collapse, etc.);
- operate the product without the required operator's inspections, periodic service inspections, and/or maintenance done as specified in this Manual (ref. Section 8 INSPECTION, MAINTENANCE, AND REPAIRS) or as specified in the custom provision of the sales contract concluded between the user and the manufacturer of the product;
- operate the fire door with mechanical damage or other defects caused by misuse, especially if it has been stopped in an emergency and the reason has not been cleared;
- operate the fire door if it or any of its components have been found to work abnormally and the relevant supervisor, maintenance team and the manufacturer's technical service have not been notified;
- operate the fire door with its nameplate defaced or removed;
- service or repair the fire door when its components are in motion;
- passing / running through a closed fire door or while its components are in motion;
- transport (hoisting/lifting/lowering) of materials and/or persons through the fire protection curtain;
- wash or clean the fire protection curtain with formulas that are corrosive and/or based on any acid or solvent, or pressure clean with any liquid (see Section 8.4 CLEANING AND LUBRICATION).

Failure to comply with the foregoing restrictions will have the user lose all liabilities and warranty obligations of the manufacturer towards the former, including loss of the declared fire resistance and the DoP issued by the manufacturer.

CAUTION!

The manufacturer shall be released from their liability and warranty obligations:

- if the product has been installed by a contractor not authorised by the manufacturer;
- for all natural, whether partial or complete, wear and tear resulting from the characteristics or intended use of the fire door (which includes exposure to fire);
- if the user or any third party alters, modifies, or replaces components or structural features of the fire door without coordination and prior written authorisation of the manufacturer;
- for misuse or failure in routine maintenance of the fire door or its components as required by this Manual;
- for failure in the periodic inspections required in this Manual or any binding, custom agreement with the manufacturer or its authorized technical service, if the failure has caused damage and other defects (including the defacement or removal of the nameplate).



 MAŁKOWSKI MARTECH Czołowo, ul. Leśna 57, 62-035 Kórnik tel. +48 61 222 75 00 fax: +48 61 222 75 01 email: biuro@malkowski.pl, www.malkowski.pl	FIRE PROTECTION CURTAIN type: MARC-Ok E1120	Ref. no.: ISOiK_Ok-1
	USE, OPERATION AND MAINTENANCE MANUAL	Revision: 12 / 2021

In the foregoing circumstances the manufacturer does not warrant that the declared fire resistance of the product will be maintained any longer.

To ensure reliable operation and compliance with the warranty terms and conditions, please contact MAŁKOWSKI-MARTECH S.A. or its commercial partner for product training. The purpose of the training is to provide the necessary information about proper use and, among others, the requirements for operating personnel.

2.3 OHS RECOMMENDATIONS

The operation of the fire door requires compliance with the prevailing general occupational health and safety laws, including legal prerequisites of fire protection and timely inspections, servicing, maintenance, parts replacement, and repairs which are specified in the requirements. Do not operate the fire door if it has been stopped in an emergency until the root cause is cleared. Follow the prevailing regulations of law for waste generation control and proper disposal during all work on the fire door. Special caution is required that during cleaning/washing, maintenance, replacement of parts or repairs of the fire door no harmful substances are released into the soil or sewers, like lubricants, solvent-borne cleaning agents, etc. These substances must be collected, contained and shipped for legal disposal in suitable containers.

2.4 SERVICE PERSONNEL REQUIREMENTS

The servicing of the fire door requires no professional license. The fire door shall be operated and serviced by an operator (e.g. a maintenance technician) designated by the fire door user. The designated operator requires operating training from the fire door manufacturer's representative or the manufacturer's authorized installation contractor; once completed, the operating training must be certified as such in writing.

The user shall ensure that the operating personnel is and remains trained in occupational health and safety, including the possible risks of this product, the job safety instructions, this Manual, and all instructions attached to this document.

3. PACKAGING, STORAGE, AND TRANSPORT

Depending on the sales contract/quotation provisions agreed to with the manufacturer, the fire door can be collected from the manufacturer's warehouse or shipped and delivered by the manufacturer to the installation side against a written proof of acceptance of the product quantity and quality on the Goods Issue Note.

The fire door is delivered in assemblies and components to be assembled and installed at the user's site. Each assembly and component is separately protected against mechanical damage for the duration of shipping as follows:

- the curtain sheath is wound onto the winding shaft, secured with a protective film and placed on a pallet with mineral wool or polystyrene spacers,
- guides, covers, etc. are placed on a pallet with mineral wool or polystyrene spacers;
- each aforementioned pallet (loading unit) is secured with foil and fastened with polyester tape through wooden securing beams,
- small accessory items, like fasteners, etc. are packed in a separate cardboard box;
- each delivery packaging is labelled with the packing list of the assemblies and components, showing the customer's purchase order, the assembly number, the fire door type, and the DoP reference number.

Transport, storage, and assembly/installation of the fire door are regulated as follows:

- The assemblies, components, and single parts of the fire door must be properly secured in transport (with lashing, straps, spacers, etc.);
- Following the unloading from delivery and for the duration of storage, store all parts of the fire door



 MAŁKOWSKI MARTECH Czołowo, ul. Leśna 57, 62-035 Kórnik tel. +48 61 222 75 00 fax: +48 61 222 75 01 email: biuro@malkowski.pl, www.malkowski.pl	FIRE PROTECTION CURTAIN type: MARC-Ok E1120	Ref. no.: ISOiK_Ok-1
	USE, OPERATION AND MAINTENANCE MANUAL	Revision: 12 / 2021

in a sheltered room, away from sources of damage, dirt, and the elements (like snow and rain);

- Do not step, walk, or drive over any assembly, component, or part of the fire door; do not place any loads, tools, or any chemicals on these items; do not lead on these items; do not attempt anything unspecified here which might contribute to damage and reduction of value/quality of the fire door items.

4. ASSEMBLY AND INSTALLATION

The electrical and mechanical installation and assembly of the fire door shall only be done by trained personnel of the manufacturer of its authorized installation contractors.

Fire door pre-installation/assembly procedure:

- Before attempting the work, inspect all delivery items for incorrect quantity and damage during transport or storage;
- Verify conformity of the installation conditions against the purchase order / sales contract drawing;
- All connections and joints must be carefully made and assembled and re-checked for proper tightening and fit.

Install the fire door in compliance with the INSTALLATION INSTRUCTIONS (ref. Section 11 APPENDICES), and follow with the installation work inspection and functional testing.

The acceptance of the installed fire door is to be done in witness of the buyer's authorized and the manufacturer's authorized representatives (it can be witnessed on behalf of the manufacturer, by the authorized installation contractor) who will certify the acceptance in the Periodic Inspection and Maintenance Log (appended to this Manual) or in a separate installation acceptance certificate.

4.1 MECHANICAL INSTALLATION

The assembly/installation of the mechanical components of the fire door shall proceed in compliance with the INSTALLATION INSTRUCTIONS (ref. Section 11 APPENDICES), which are dedicated engineering documents intended only for the installation contractor's foremen who hold the relevant installation certificates issued by the fire door manufacturer.

CAUTION!

For proper handling, lifting, and fastening of the fire door structure, ensure proper OHS conditions and the work equipment required for the tasks, like ladders of suitable height, fall arrest harnesses, lifelines and other gear, e.g. slings, lifting beams, a hoist, or a MEWP with a lift capacity and outreach sufficient for the weight and installation height of the product's structure.

The sales contract specifies the party required to secure the work equipment for the assembly, installation, and periodic inspections/maintenance processes.

4.2 ELECTRICAL INSTALLATION

The configuration of the electrical accessories for the fire door depends on the purchase order specifications and their installation must conform to the engineering documentation (for the installation contractor) appended to this Manual.

The electrical wiring diagram is shown inside of the control panel cover and in the electrical accessories installation manual appended to this Manual (ref. Section 11 APPENDICES).

CAUTION!

The fire door user shall prepare the electrical power connection at the fire door installation site for this product. The electrical power connection shall have compatible electrical and protection ratings to permit wiring to the fire door, its functional testing, and normal operation.

The electrical power connection must be wired to the fire protection curtain electrical accessories, tested, and repaired whenever it fails by a suitably licensed professional electrician only.



 MAŁKOWSKI MARTECH Czołowo, ul. Leśna 57, 62-035 Kórnik tel. +48 61 222 75 00 fax: +48 61 222 75 01 email: biuro@malkowski.pl, www.malkowski.pl	FIRE PROTECTION CURTAIN type: MARC-Ok E1120	Ref. no.: ISOiK_Ok-1
	USE, OPERATION AND MAINTENANCE MANUAL	Revision: 12 / 2021

5. OPERATING PRINCIPLE OF THE ELECTRICAL ACCESSORIES KIT

The primary function of the electrical accessories (ref. Sections 6.6 to 6.9 ELECTRICAL ACCESSORIES KIT) is the automatic activation of the curtain sheath deployment to the so-called technically closed position as soon as a fire hazard is detected. A detailed description of the structure, installation and operation of the fire alarm and detection accessories delivered with the fire door is included in the electrical accessories installation manual appended to this Manual.

The fire protection curtain electrical accessories kits are also equipped with rechargeable batteries, which enable the curtain sheet to be unfolded (closed) in the event of a power failure, including a minimum of one roll-up (e.g. after a false fire alarm). Carrying out service inspection or maintenance requires mains electricity. Manual control of the curtain sheet winding up / winding down is carried out using the elevated control panel shown below.

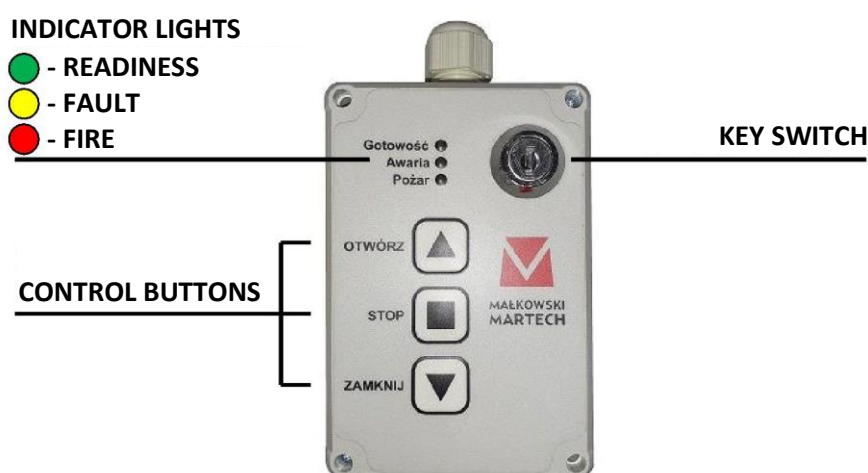

Fig. 1 – Elevated control panel for fire protection curtain type MARC-Ok

The process of manually activating the winding up and winding down of the curtain sheet, i.e. the movement of the electric drive motor, is only possible with the key in the key switch.

6. TECHNICAL SPECIFICATIONS

Door

Specification	Value	Notes
Fire resistance class	E160, E12120, EW120	-
Closing speed	< 0.15 m/s	-
Operation (manual / powered)		operation exclusively by means of an electric drive (emergency manual opening is possible in the case of drives equipped with such a system)
Sheet colour	similar to RAL 7035	-
Colour of guide rail assembly fascia and shaft box	galvanised / RAL 7035, 9002, 9010	Any in the RAL palette on request

Electric drive

Type of drive	Voltage / amperage	Notes
tubular VIC-0403	24 V DC / 2.3 A	drive application depends on the door size
tubular VIC-0423	230 V AC / 1.05 A	
tubular VIC-0426	230 V AC / 1.8 A	
tubular VIC-0428	230 V AC / 3.2 A	
tubular VIC-0429	230 V AC / 3.9 A	
tubular VIC-0430	230 V AC / 4.4 A	
tubular VIC-0431	230 V AC / 5.3 A	
tubular VIC-0101	24 V DC / 6.3 A	
tubular VIC-0102	24 V DC / 5.0 A	
tubular VIC-0103	24 V DC / 6.8 A	
tubular VIC-0122	230 V AC / 24 V DC / 1.2 A	drives with gravitational fall, drive application depends on the door size
tubular VIC-0123	230 V AC / 24 V DC / 1.9 A	
tubular VIC-0124	230 V AC / 24 V DC / 1.9 A	

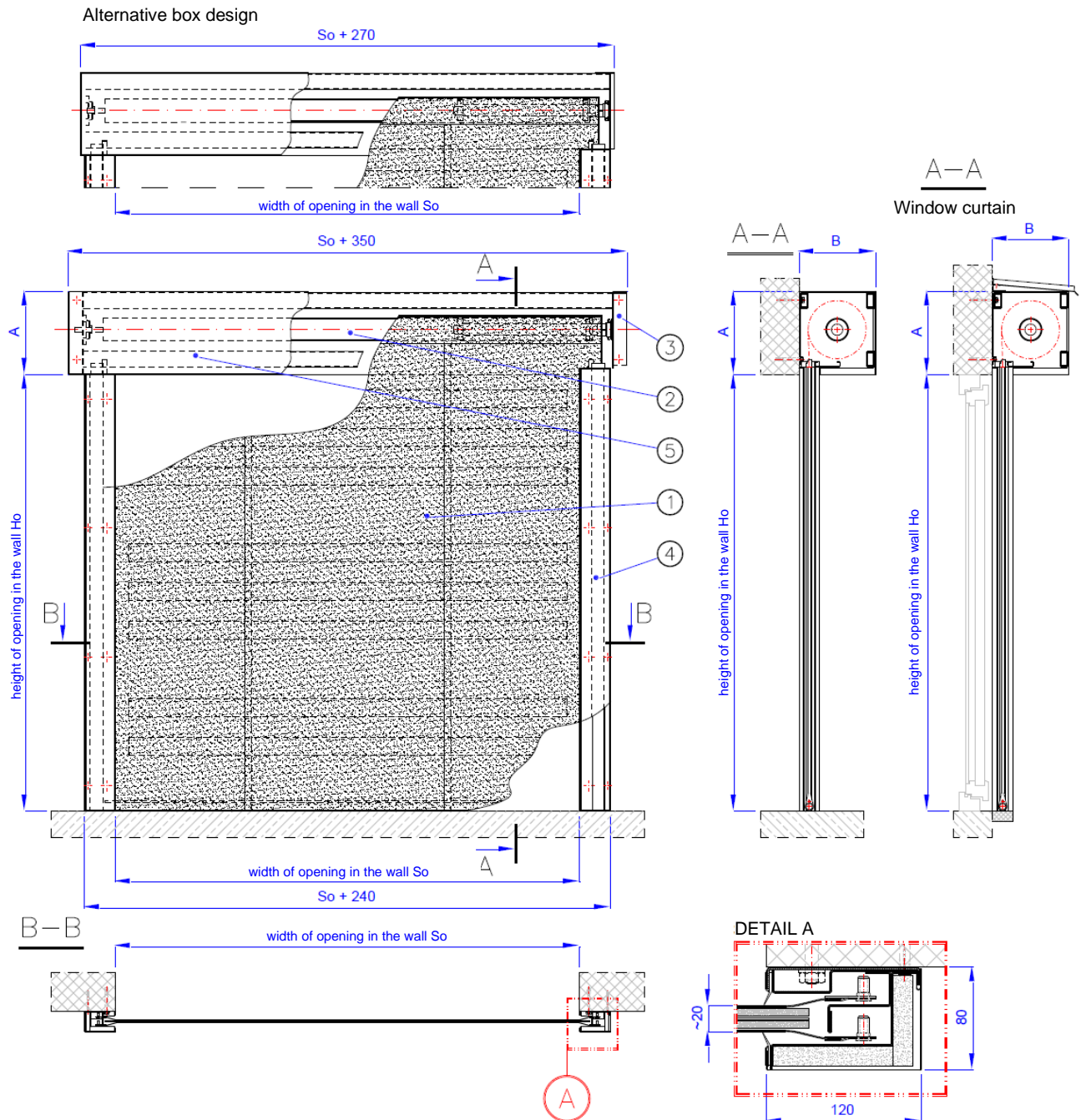

Fig. 2 – MARC-Ok E120 fire protection curtain

1 – Curtain sheath, 2 – Winding shaft, 3 – Shaft support, 4 – Guide, 5 – Cover assembly (shaft box)

Note. Electrical accessories are optional, see sections 6.6 - 6.9.

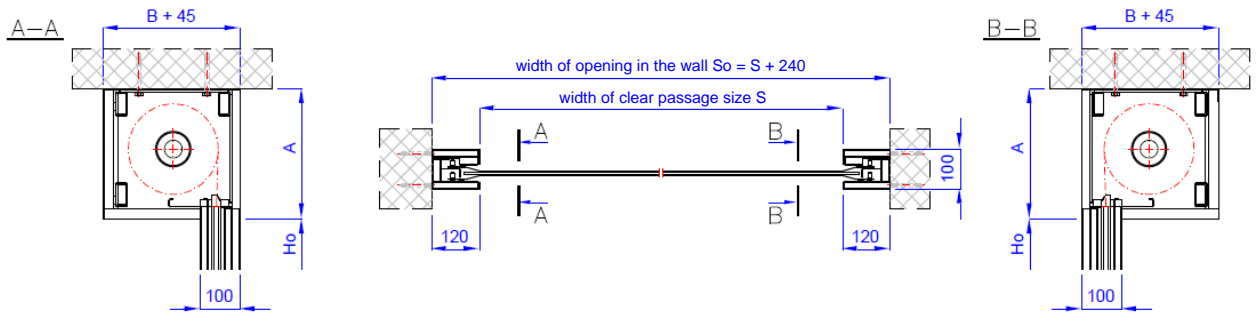

Fig. 3 – MARC-Ok E120 fire protection curtain
– corridor installation (between parallel walls)

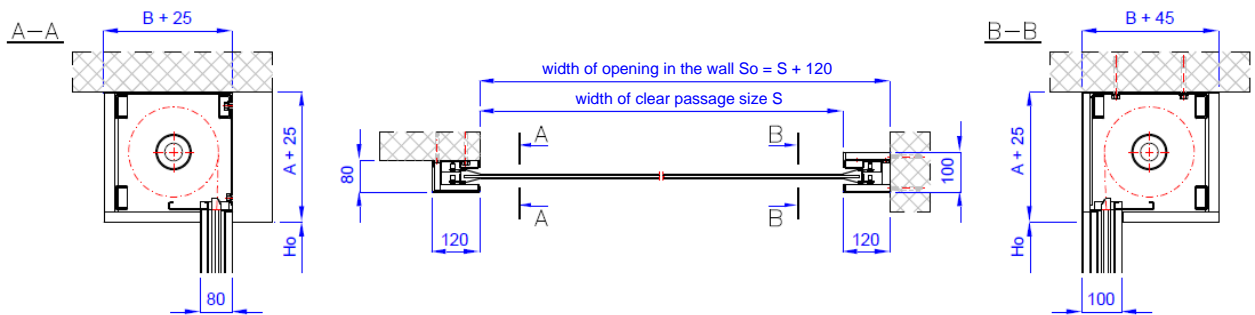

Fig. 4 – MARC-Ok E120 fire protection curtain
– mixed installation

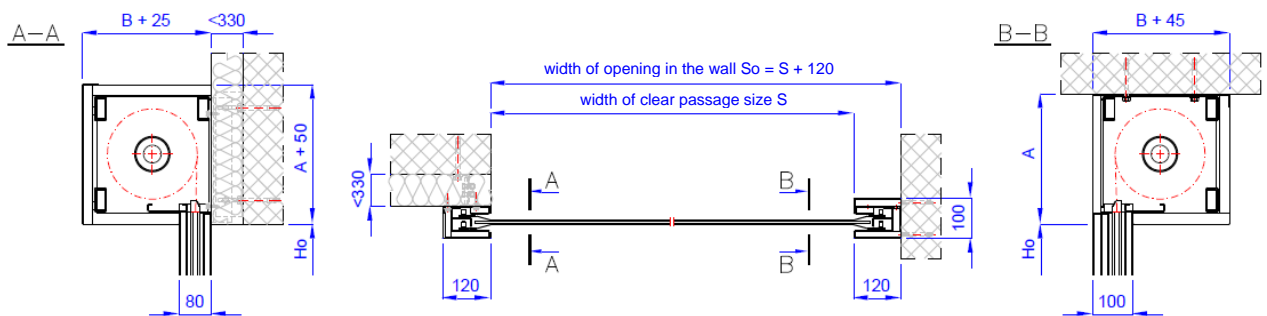



Fig. 5 – MARC-Ok E120 fire protection curtain
– mixed installation, single-sided on spacers

List of components for type MARC-Ok E120 fire protection curtain

#	Designation	Quantity	Drawing no./ Part no. / Standard
1	Curtain sheet	1	6 - MARC-Ok120-01.01.00
2	Winding shaft	1	7 - MARC-Ok120-01.02.00
3	Shaft support	2	8 - MARC-Ok120-01.03.00
4	Guide rail	2	9 - MARC-Ok120-01.04.00
5	Cover assembly (shaft box)	1	10 - MARC-Ok120-01.05.00

 MAŁKOWSKI MARTECH Czołowo, ul. Leśna 57, 62-035 Kórnik tel. +48 61 222 75 00 fax: +48 61 222 75 01 email: biuro@malkowski.pl, www.malkowski.pl	FIRE PROTECTION CURTAIN type: MARC-Ok E120	Ref. no.: ISOiK_Ok-1
	USE, OPERATION AND MAINTENANCE MANUAL	Revision: 12 / 2021

LIST OF ANCHORING ELEMENTS FOR SHAFT SUPPORTS

- NOTE:
1. The standard set of fasteners supplied with the product includes the hardware for installation on concrete (C20/25) and reinforced concrete walls.
 2. It is possible to use different fasteners provided if they are marketed with the CE marking or the Polish Construction Mark "B" and have the same or better strength and the same intended use.

#	Anchoring fasteners	Notes
A. REGULAR/PRESTRESSED CONCETE HOLLOW CORE SLABS		
A.1	Anchor for hollow core slabs Fischer FHY, Hilti HKH	- the size and type are specified for the transmitted loads,
A.2	Sleeve anchor (driven) e.g. Fischer EA II, Hilti HKD	
B. WALLS, FLOORS, AND BEAMS OF SOLID/RF CONCRETE		
B.1	Bolt (ring) anchor e.g. MKT BZ, Fischer FAZ II, Hilti HST3	- the size and anchoring depth are specified for the transmitted loads,
B.2	Sleeve anchor (driven) e.g. Fischer EA II, Hilti HKD	
B.3	Threaded anchor e.g. Fischer FBS II; Hilti HUS HR/CR	
B.4	Chemical fixing with threaded rod e.g. MKT VM Multi-plus, Fischer FIS SB	- Min. bar size M8 (DIN 976), min. strength class 8.8 (PN-EN ISO 898-1)
C. MASONRY WALLS OF CELLULAR CONCRETE UNITS (e.g. Ytong, Solbet, or Termalica)		
C.1	Threaded anchor e.g. Fischer FBS II; Hilti HUS HR/CR	- the size and anchoring depth are specified for the transmitted loads,
C.2	Fischer FPX M8-I / M10-I / M12-I anchor	
C.3	Chemical fixing with threaded bar e.g. MKT VM Multi-plus, Fischer FIS V, FIS P	- Min. bar size M8 (DIN 976), min. strength class 8.8 (PN-EN ISO 898-1)
C.4	Through-and-through fastening with threaded bars	- DIN 976 bar; the size is specified for the transmitted loads, min. class 8.8 (PN-EN ISO 898-1) - PN-EN ISO 4032 nut, min. strength class 8; - PN-EN ISO 7093 wide washer 200 HV;
D. SOLID MASONRY WALLS (e.g. concrete blocks, silicate blocks, solid bricks) AND ROLLING BRICKS (e.g. perforated blocks, porotherm)		
D.1	Chemical fixing with threaded bar e.g. MKT VM Multi-plus, Fischer FIS V, FIS P	- Min. bar size M8 (DIN 976), min. strength class 8.8 (PN-EN ISO 898-1)
D.2	Threaded anchor e.g. Fischer FBS II; Hilti HUS HR/CR	- the size and anchoring depth are specified for the transmitted loads,
D.3	Through-and-through fastening with threaded bars	- as in C.4 with replacement of the washers, - PN-EN ISO 4079 washer, 200 HV;
E. FIRE-PROOFED STEEL STRUCTURES AND FIRE STUD WALLS ¹⁾		
E.1	Screws for steel structures (sheet metal screws) e.g. Hilti S-MD, Stalco WS / FD / FM, Etanco GT	- min. St 4.8 x 25 (DIN 7504); - the size is specified for the transferred loads,
E.2	Threaded fastening	- PN-EN ISO 4014 / 4017 bolt; the size is specified for the transmitted loads, min. class 8.8 (PN-EN ISO 898-1) - PN-EN ISO 4079 washer, 200 HV; - PN-EN ISO 4032 nut, min. strength class 8;

1) – The inner steel profiles must withstand the static and dynamic loads of the fire protection curtain installation and operation.



LIST OF ANCHORING ELEMENTS FOR GUIDE ANCHORS ²⁾

F. REINFORCED CONCRETE WALLS, MASONRY OF AERATED CONCRETE BLOCKS, SOLID AND HOLLOW MASONRY		
F.1	Steel wall plug (frame anchor)	- M8; M10; - Min. length 72 mm;
F.2	Plastic frame anchor plug, Hilti HRD-CR	- Size 8, 10 - Min. length 60 mm;

2) – Hardware listed in B, C, D, and E may also be used.

6.1 CURTAIN SHEET

The sheet is the main part of the curtain. When closed (unwound), it forms a sealed, integral partition with the fire resistance rating of EI120.

The jacket consists of five layers, two identical outer layers of approximately 1.5 mm thick type FM1D, two core side layers of approximately 6 mm thick type MH-6 and a core middle layer of 2.0 mm thick type FM2D. The total curtain sheet thickness is approx. 20 mm.

The upper edge of the sheet is fixed to the winding shaft with steel self-drilling screws. Inside the bonded materials of the curtain sheet and along the entire clear opening width, plus 30 mm from each side edge, is a counterweight unit made of a 30 mm dia. steel bar.

The vertical edges of the curtain sheet carry guideways made of M6 x 20 rivet nuts and mounting plates, which run inside of the guide rail profiles.

Curtain sheet specifications

Specification	U.m.	Value	Notes
Width / height / thickness	mm	$H_o^{1)} + X / S_o^{2)} + 135 / 20$	dimension "X" depends on the diameter of the winding shaft
Colour	-	grey, similar to RAL 7035	-
Quantity	pcs.	1	-
Total weight	kg / m ²	9.5	-

1) – Door (construction partition) clear opening height; 2)- Door clear width

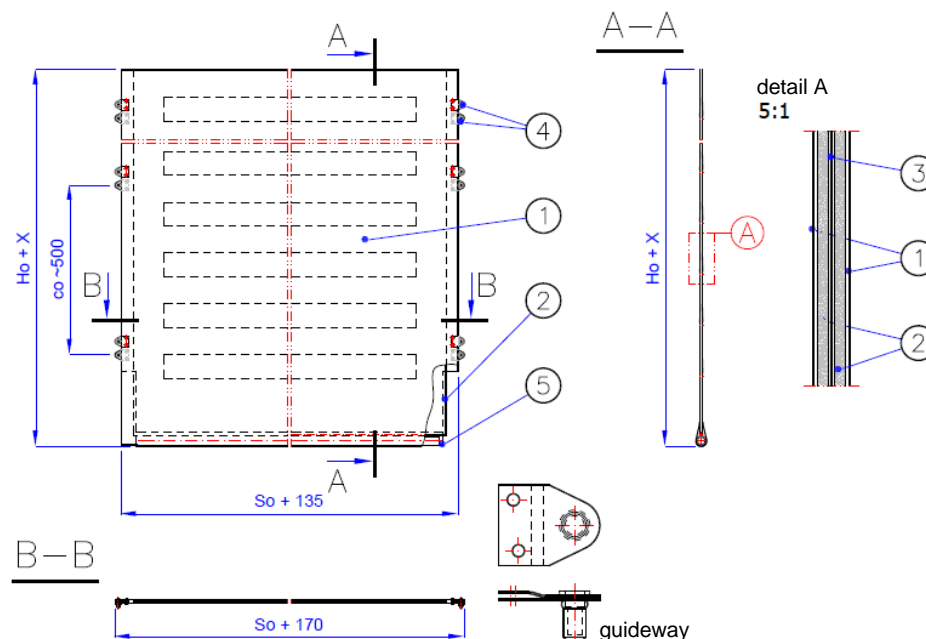



Fig. 6 – MARC-Ok120-01.01.00 [Door sheet]

1 – Outer layer, 2 – Side core layer, 3 – Middle core layer, 4 – Guideway, 5 – Counterweight bar

 MAŁKOWSKI MARTECH Czołowo, ul. Leśna 57, 62-035 Kórnik tel. +48 61 222 75 00 fax: +48 61 222 75 01 email: biuro@malkowski.pl, www.malkowski.pl	FIRE PROTECTION CURTAIN type: MARC-Ok E1120	Ref. no.: ISOiK_Ok-1
	USE, OPERATION AND MAINTENANCE MANUAL	Revision: 12 / 2021

Door sheet: list of components

#	Designation	Qty.	Replacement / Repair			Notes
			U ¹⁾	A ²⁾	P ³⁾	
1	Outer layer	2	-	-	Yes	-
2	Side core layer	1	-	-	Yes	-
3	Middle core layer	2	-	-	Yes	-
4	Guide	2*	-	Yes	Yes	* – per side, every ~500 mm
5	Counterweight bar	1	-	Yes	Yes	-

1) – Done by the user, 2) – Done by the authorized service, 3) – Done by the manufacturer

CAUTION! If the parts to be serviced by manufacturer only is replaced by anyone else, it will immediately void the CE marking of the product and the product's performance, including the fire resistance rating.

6.2 WINDING SHAFT

The sheet is attached to the winding shaft. The shaft, rotating, causes the curtain door to close/open. It is made of a steel tube with a section of 88.9 x 3.6; 127.0 x 4.5; 159.0 x 4.5; 244.5 x 7.1; 323.9 x 8.8 – depending on the dimensions of the entire curtain door.

On one side, the shaft is terminated by a journal which allows the shaft to be seated in a UCF series self-aligning bearing bolted to the shaft support. On the other side, a tubular drive is mounted inside the shaft, which is bolted to the second shaft support via a special bracket.

Winding shaft specifications

Specification	U.m.	Value	Notes
Length (shaft tube)	mm	$S_o^{1)} + 80$	-
Diameter	mm	88.9, 127, 159, 244.5, 323.9	depends on the door size
Quantity	pcs.	1	-
Total weight	kg/m	8.5 - 75	depends on the tube type

1) – Width (partition) clear height

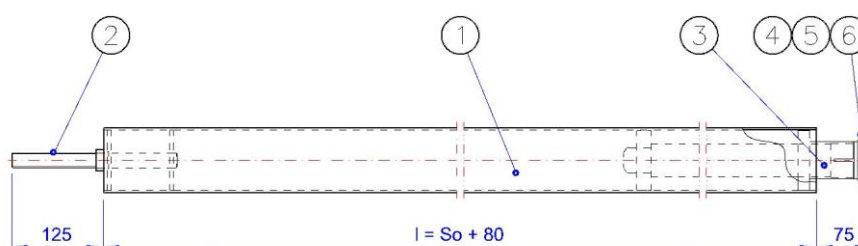



Fig. 7 – MARC-Ok120-01.02.00 [Winding shaft]

1 – Shaft tube, 2 – Journal, 3 – VIC type drive, 4 – M6x16 bolt, 5 – M6 nut, 6 – 6.1 Spring washer

 MAŁKOWSKI MARTECH Czołowo, ul. Leśna 57, 62-035 Kórnik tel. +48 61 222 75 00 fax: +48 61 222 75 01 email: biuro@malkowski.pl, www.malkowski.pl	FIRE PROTECTION CURTAIN type: MARC-Ok E120	Ref. no.: ISOiK_Ok-1
	USE, OPERATION AND MAINTENANCE MANUAL	Revision: 12 / 2021

Winding shaft: list of components

#	Designation	Qty.	Replacement / Repair			Notes
			U ¹⁾	A ²⁾	P ³⁾	
1	Shaft tube	1	-	Yes	Yes	-
2	Journal	1	-	Yes	Yes	-
3	VIC type drive	1	-	Yes	Yes	type depending on door dimensions
4	M6 x 16 hex head bolt	4	-	Yes	Yes	PN-EN ISO 4017 / DIN 933, class 8.8
5	M6 hex nut	4	-	Yes	Yes	PN-EN ISO 4032, class 8
6	6.1 mm spring washer	4	-	Yes	Yes	DIN 127

1) – Done by the user, 2) – Done by the authorized service, 3) – Done by the manufacturer

CAUTION! If the parts to be serviced by manufacturer only is replaced by anyone else, it will immediately void the CE marking of the product and the product's performance, including the fire resistance rating.

6.3 SHAFT SUPPORT

Shaft supports are used to fix the winding shaft to the wall/ceiling of the building and as supports for mounting the cover assembly. The MARC-Ok fire protection curtain includes two shaft supports made from 4 mm thick galvanised steel sheet of , grade DX51D+Z275 to EN 10346:2015-09. A self-aligning bearing in a UCF-type cast iron housing is attached to the passive side support with washers and screws. The VIC type electric drive is attached to the drive side support by means of a special bracket. The type of anchoring elements depends on the material / type of wall / ceiling. A summary of the anchoring elements is included in the table on page 12.

Shaft support specifications

Specification	U.m.	Value	Notes
Width / height	mm	250 x 250 - 600 x 600	depends on the door size
Thickness	mm	58	-
Quantity	pcs.	2	-
Total weight	kg / pc.	2.30 - 13.0	depends on the support size

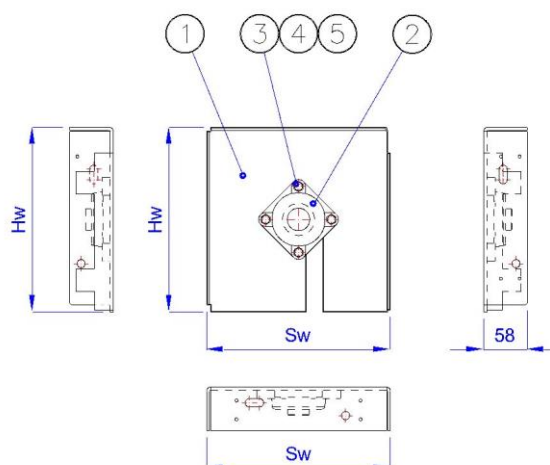



Fig. 8 – MARC-Ok120-01.03.00 [Shaft support]

1 – Support plate, 2 – UCF self-aligning bearing, 3 – M10x30 bolt, 4 – M10 nut, 5 – 10.2 Spring washer

 MAŁKOWSKI MARTECH Czołowo, ul. Leśna 57, 62-035 Kórnik tel. +48 61 222 75 00 fax: +48 61 222 75 01 email: biuro@malkowski.pl, www.malkowski.pl	FIRE PROTECTION CURTAIN type: MARC-Ok EI120	Ref. no.: ISOiK_Ok-1
	USE, OPERATION AND MAINTENANCE MANUAL	Revision: 12 / 2021

Shaft support: list of components

#	Designation	Qty.	Replacement / Repair			Notes
			U ¹⁾	A ²⁾	P ³⁾	
1	Support plate	2	-	Yes	Yes	-
2	UCF self-aligning bearing	1	-	Yes	Yes	for passive side support only
3	M10 x 30 hex head bolt	4	Yes	Yes	Yes	PN-EN ISO 4017 / DIN 933, class 8.8
4	M10 hex nut	4	Yes	Yes	Yes	PN-EN ISO 4032, class 8
5	10.2 spring washer	4	Yes	Yes	Yes	DIN 127

1) – Done by the user, 2) – Done by the authorized service, 3) – Done by the manufacturer

CAUTION! If the parts to be serviced by manufacturer only is replaced by anyone else, it will immediately void the CE marking of the product and the product's performance, including the fire resistance rating.

6.4 GUIDE RAIL

The guide rails (two pieces) guarantee the correct positioning of the door curtain in the opening. Their cross-sectional dimension is 80 x 120 mm. The wall-side and middle sections are made of a 1.5 and 2.0 mm thick galvanized steel sheet, grade DX51D+Z275 (PN-EN 10346:2015-09) protected with 10 and 20 mm thick fire protection panels. The guide rail fascia is made from 0.7 mm galvanized steel sheet. EPDM cover gaskets are fitted to the edges of the guide rail recess. The type of anchoring elements depends on the material / type of wall / ceiling. A summary of the anchoring elements is included in the table on page 12.

Guide rail specifications

Specification	U.m.	Value	Notes
Length	mm	Ho ¹⁾ + 70	-
Width / thickness	mm	120 x 80	-
Colour	-	galvanized / any in the RAL palette on request	Standard colours: RAL 7035, 9010, 9002
Quantity	pcs.	2	-
Total weight	kg/m	11.15	-

1) – Door (partition) clear height

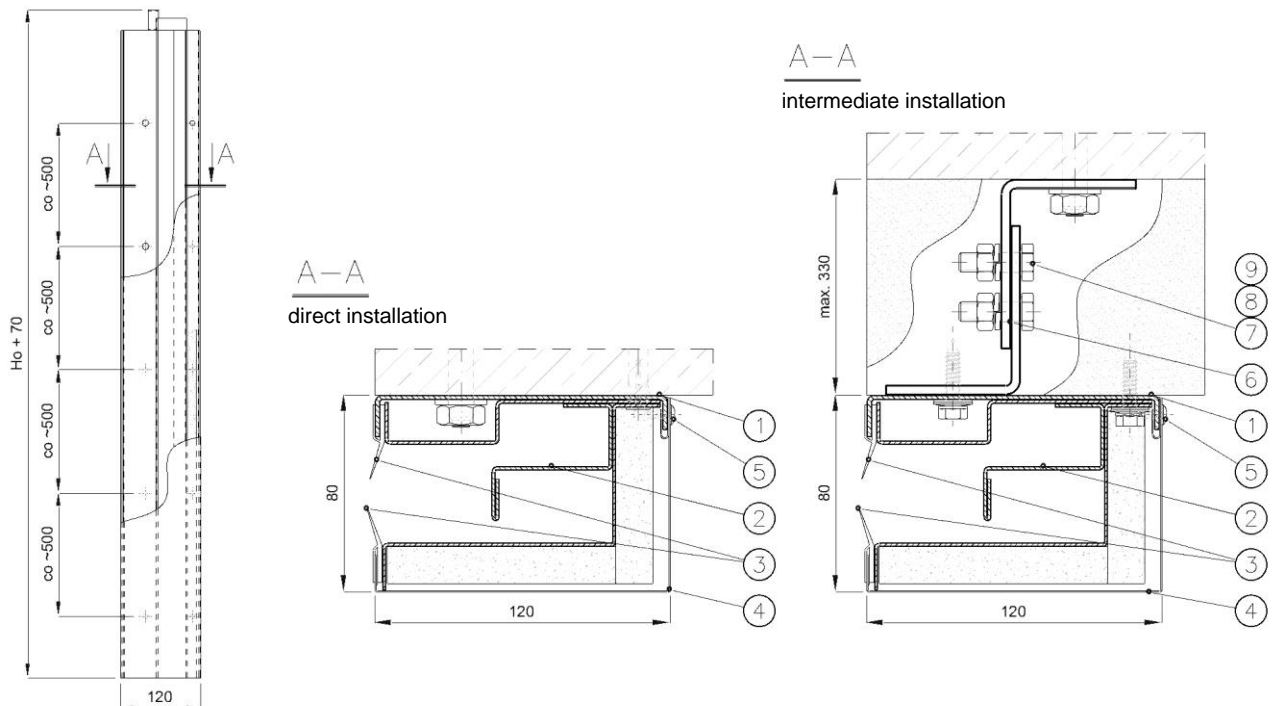

Fig. 9 – MARC-Ok120-01.04.00 [Guide rail]

1 – Wall-side section, 2 – Middle section, 3 – Gasket, 4 – Fascia, 5 – 4.2x19 self-drilling screw,
6 – Spacer bracket, 7 – M10x30 bolt, 8 – 10.2 spring washer, 9 – M10 nut

Guide rail: list of components

#	Designation	Qty.	Replacement / Repair			Notes
			U ¹⁾	A ²⁾	P ³⁾	
1	Wall-side section	1	-	Yes	Yes	-
2	Middle section	1	-	Yes	Yes	-
3	Gasket	2	-	Yes	Yes	length equal to the length of the guide rail
4	Fascia	1	-	Yes	Yes	-
5	4.2 x 19 self-drilling screw	1*	-	Yes	Yes	* – every ~500 mm, DIN 7504 N
6	Spacer bracket	1*	-	Yes	Yes	* – every 1000 mm, only for indirect installation
7	M10 x 30 hex head bolt	2*	-	Yes	Yes	* – every 1000 mm, PN-EN ISO 4017 / DIN 933, class 8.8
8	10.2 spring washer	2*	-	Yes	Yes	* – every 1000 mm; DIN 127
9	M10 hex nut	2*	-	Yes	Yes	* – every 1000 mm, PN-EN ISO 4032, class 8

1) – Done by the user, 2) – Done by the authorized service, 3) – Done by the manufacturer

CAUTION! If the parts to be serviced by manufacturer only is replaced by anyone else, it will immediately void the CE marking of the product and the product's performance, including the fire resistance rating.

 MAŁKOWSKI MARTECH Czołowo, ul. Leśna 57, 62-035 Kórnik tel. +48 61 222 75 00 fax: +48 61 222 75 01 email: biuro@malkowski.pl, www.malkowski.pl	FIRE PROTECTION CURTAIN type: MARC-Ok E1120	Ref. no.: ISOiK_Ok-1
	USE, OPERATION AND MAINTENANCE MANUAL	Revision: 12 / 2021

6.5 COVER ASSEMBLY

The cover assembly has an aesthetic and fire protection function, and also protects and shields the shaft together with the supports and sheet.

The cover set comprises a rear cover with sheet sliding profile, a front cover, a push bar and two side covers. All components are made of a 0.7-1.0 mm thick galvanized steel sheet, grade DX51D+Z275 (PN-EN 10346:2015-09).

The individual components of the cover assembly are connected to each other and to the shaft supports using steel self-drilling screws or steel blind rivets.

Cover assembly specifications

Specification	U.m.	Value	Notes
Height / width	mm	250 x 250 - 600 x 600	depends on the door size
Length	mm	So ¹⁾ + 370	-
Colour	-	galvanized	Any in the RAL palette on request
Quantity	sets	1	-
Total weight	kg/m	13 - 30	depends on the door size

1) – Width (partition) clear height

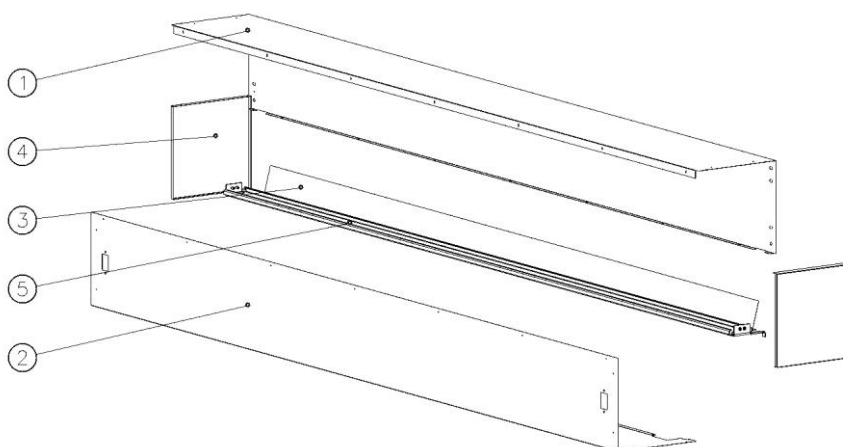

Fig. 10 – MARC-Ok60-01.05.00 [Cover assembly]

1 – Rear cover, 2 – Front cover, 3 – Sliding profile, 4 – Side cover, 5 – Push bar

Cover assembly: list of components

#	Designation	Qty.	Replacement / Repair			Notes
			U ¹⁾	A ²⁾	P ³⁾	
1	Rear cover	1	-	Yes	Yes	-
2	Front cover	1	-	Yes	Yes	-
3	Sliding profile	1	-	Yes	Yes	-
4	Side cover	2	-	Yes	Yes	-
5	Push bar	1	-	Yes	Yes	-

1) – Done by the user, 2) – Done by the authorized service, 3) – Done by the manufacturer

CAUTION! If the parts to be serviced by manufacturer only is replaced by anyone else, it will immediately void the CE marking of the product and the product's performance, including the fire resistance rating.

 <p>Czołowo, ul. Leśna 57, 62-035 Kórnik tel. +48 61 222 75 00 fax: +48 61 222 75 01 email: biuro@malkowski.pl, www.malkowski.pl</p>	FIRE PROTECTION CURTAIN type: MARC-Ok E1120	Ref. no.: ISOiK_Ok-1
	USE, OPERATION AND MAINTENANCE MANUAL	Revision: 12 / 2021

6.6 ELECTRICAL ACCESSORIES KIT - VIC-0403

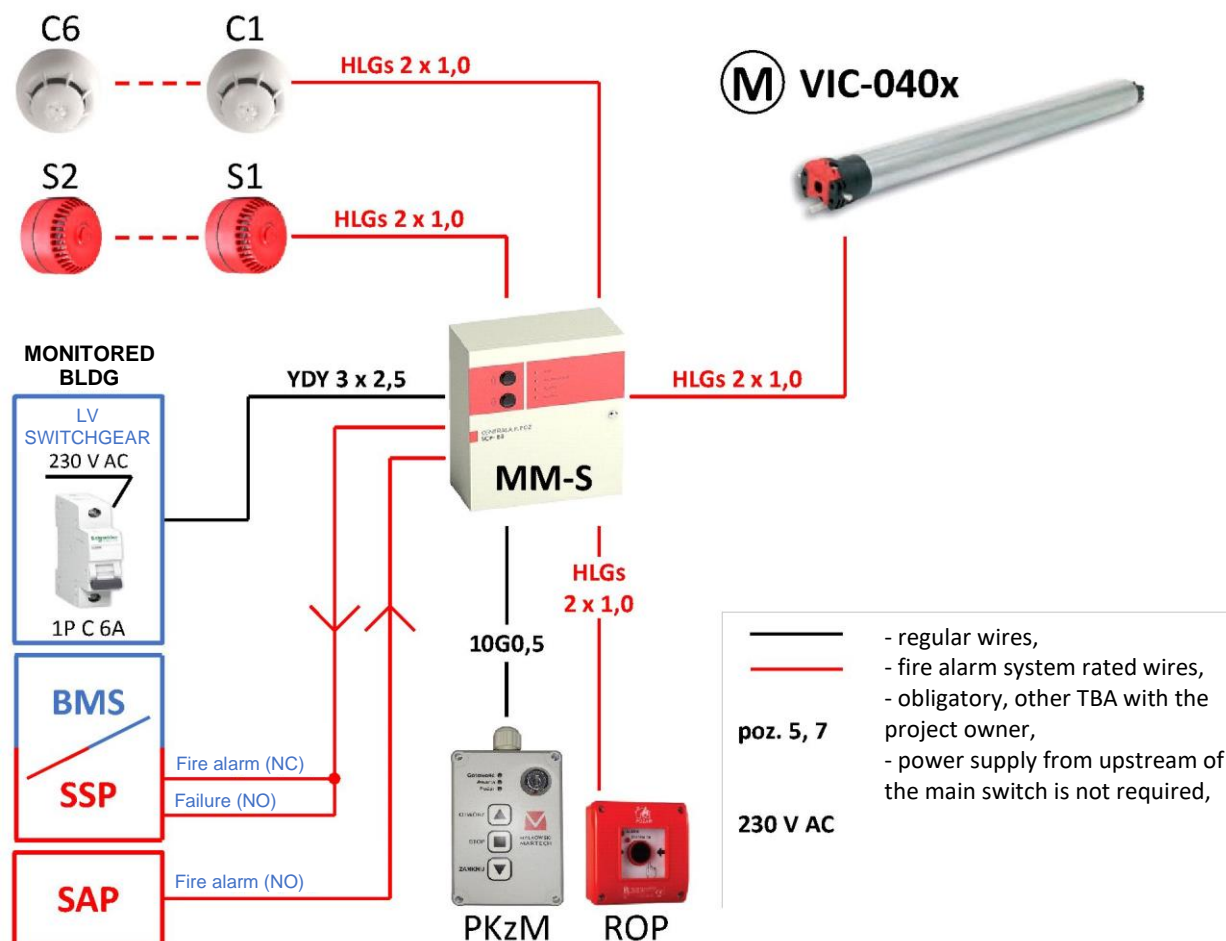

Fig. 11 – MARC- Ok control system with internal (tubular) 24 V DC drive unit

#	Figure designations	Item type	Item designation	Item code	Recommended quantity	Notes
1	C1 — C6	Spot-type fire detector	Optical smoke detector	ID100	2	ID100 is recommended, max. 6 pcs.
			Class A1R heat detector	ID200	2	
			Smoke and heat detector	ID300	2	
2	C1 — C6	Detector receptacle	Standard fire detector receptacle	EB0010	2	Qty = detector qty
3	ROP	Manual call point	Standard manual call point	ROP OP1	1	max. 10 pcs.
4	S1, S2	Fire alarm indicator	Fire alarm sounder, low base	SPP-100	1	max. current 200 mA
5	M	Electric drive	internal (tubular)	VIC-040x	1	
6	PKzM	panel	elevated control panel	PKzM	1	
7	MM-S	Control unit	Universal drive controller	MM-S	1	

6.7 VIC-012x ELECTRICAL ACCESSORIES KIT

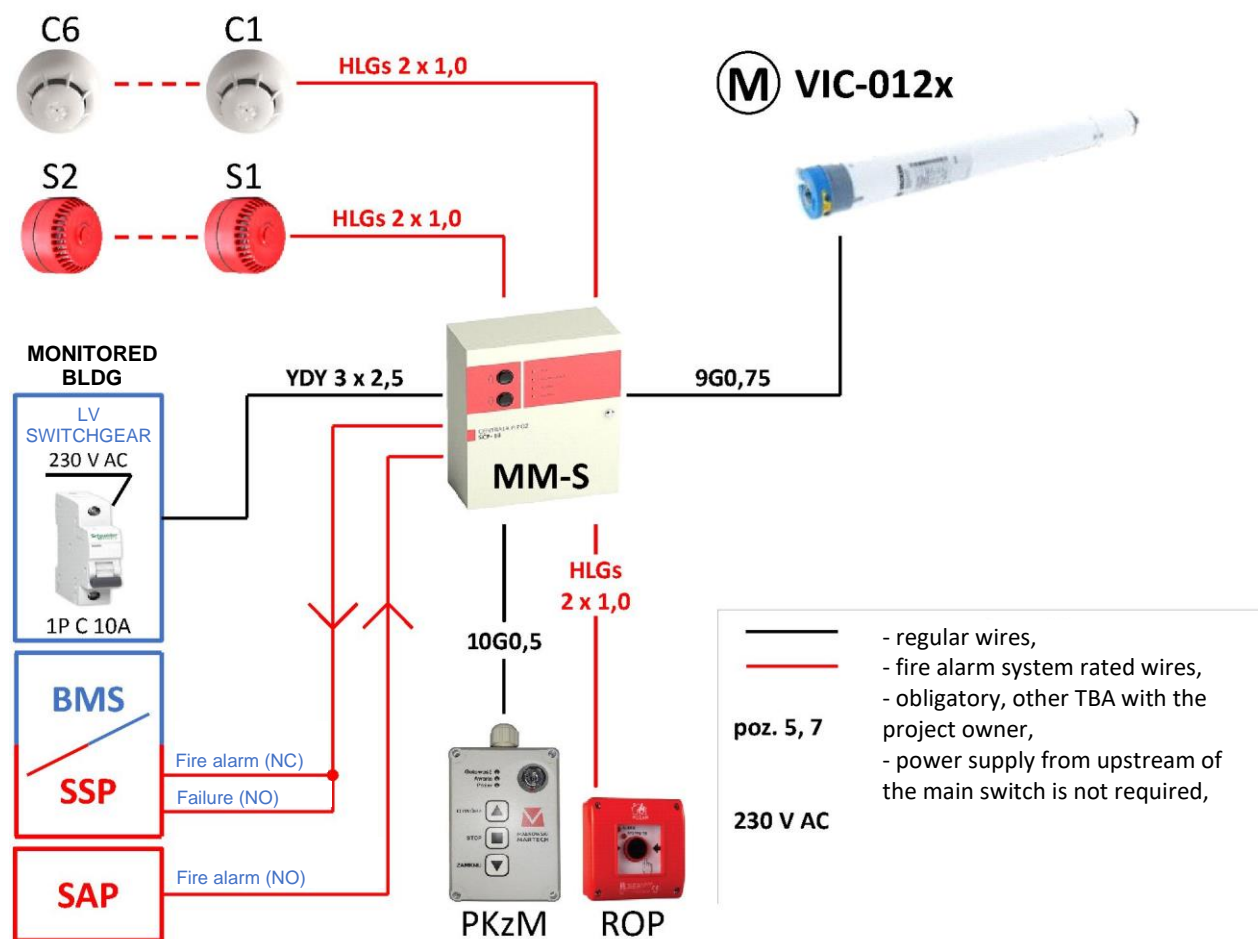

Fig. 12 – MARC-Ok control system with internal (tubular) 230 V AC drive unit with gravitational fall

#	Figure designations	Item type	Item designation	Item code	Recommended quantity	Notes
1	C1 – C6	Spot-type fire detector	Optical smoke detector	ID100	2	ID100 is recommended, max. 6 pcs.
			Class A1R heat detector	ID200	2	
			Smoke and heat detector	ID300	2	
2	C1 – C6	Detector receptacle	Standard fire detector receptacle	EB0010	2	Qty = detector qty
3	ROP	Manual call point	Standard manual call point	ROP OP1	1	max. 10 pcs.
4	S1, S2	Fire alarm indicator	Fire alarm sounder, low base	SPP-100	1	max. current 200 mA
5	M	Electric drive	internal (tubular)	VIC-012x	1	
6	PKzM	panel	elevated control panel	PKzM	1	
7	MM-S	Control unit	Universal drive controller	MM-S	1	

6.8 VIC-042x ELECTRICAL ACCESSORIES KIT

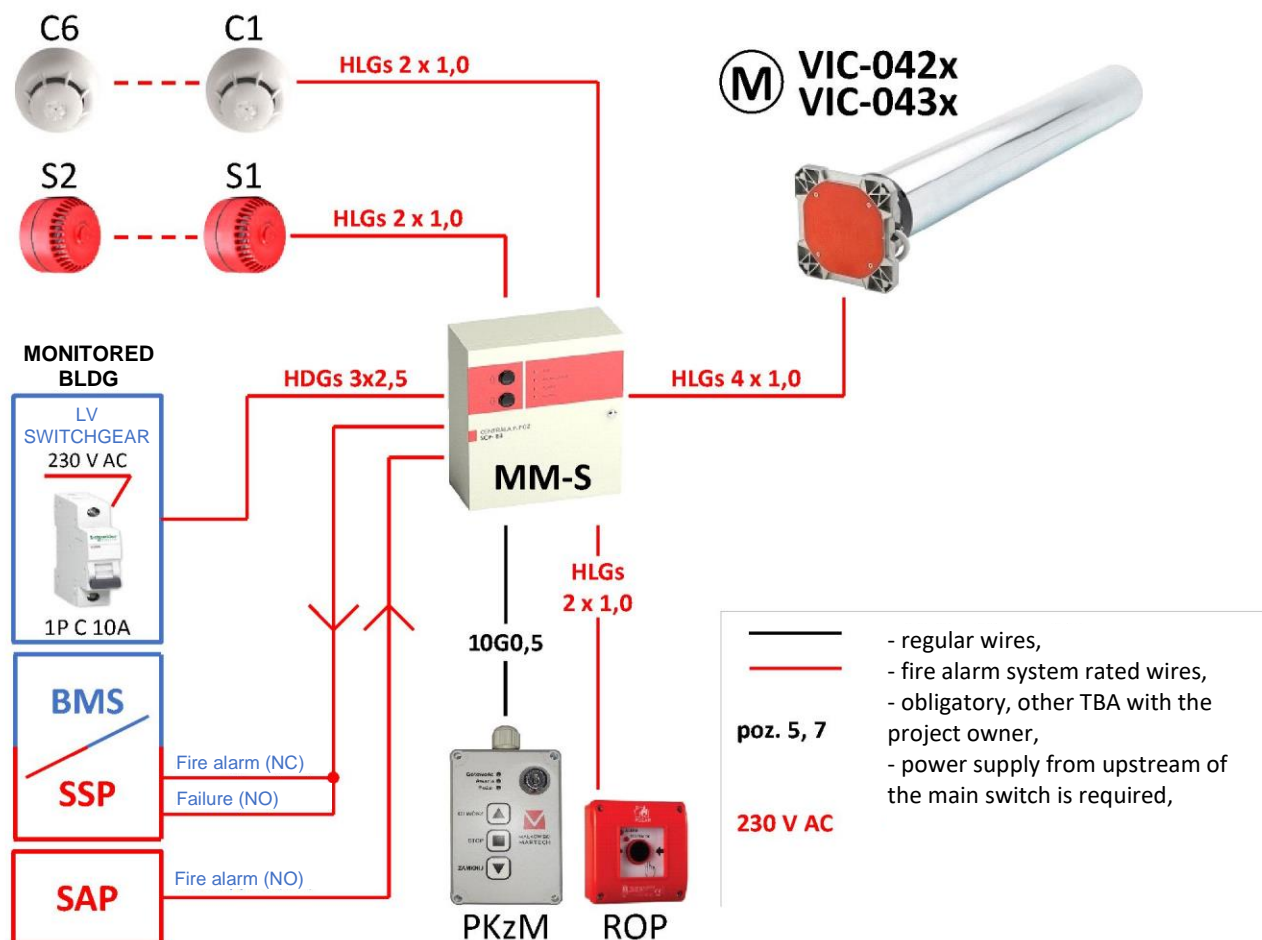



Fig. 13 – MARC-Ok control system with internal (tubular) 230 V AC drive unit of the power supply from upstream of the main switch*

#	Figure designations	Item type	Item designation	Item code	Recommended quantity	Notes
1	C1 - C6	Spot-type fire detector	Optical smoke detector	ID100	2	ID100 is recommended, max. 6 pcs.
			Class A1R heat detector	ID200	2	
			Smoke and heat detector	ID300	2	
2	C1 - C6	Detector receptacle	Standard fire detector receptacle	EB0010	2	Qty = detector qty
3	ROP	Manual call point	Standard manual call point	ROP OP1	1	max. 10 pcs.
4	S1, S2	Fire alarm indicator	Fire alarm sounder, low base	SPP-100	1	max. current 200 mA
5	M	Electric drive	internal (tubular)	VIC-04xx	1	
6	PKzM	panel	elevated control panel	PKzM	1	
7	MM-S	Control unit	Universal drive controller	MM-S	1	

* – power supply from upstream the main switch is the most economically advantageous option, although not the only one – please contact Małkowski-Martech S.A. for more details.

 <p>Czołowo, ul. Leśna 57, 62-035 Kórnik tel. +48 61 222 75 00 fax: +48 61 222 75 01 email: biuro@malkowski.pl, www.malkowski.pl</p>	FIRE PROTECTION CURTAIN type: MARC-Ok EI120	Ref. no.: ISOiK_Ok-1
	USE, OPERATION AND MAINTENANCE MANUAL	Revision: 12 / 2021

6.9 VIC-042x ELECTRICAL ACCESSORIES KIT

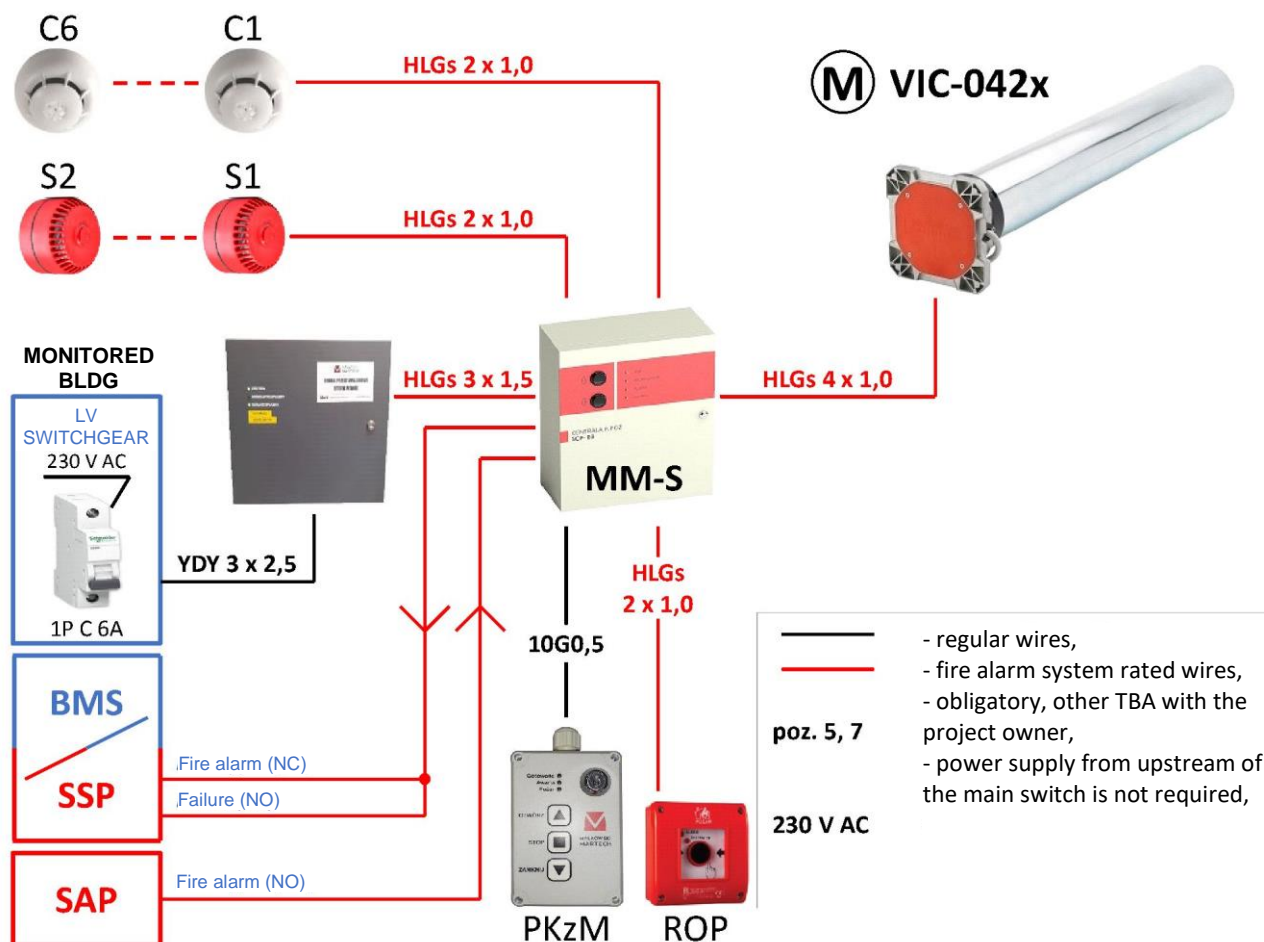



Fig. 14 – MARC-Ok control system with internal (tubular) 230 V AC drive unit with inverter

#	Figure designations	Item type	Item designation	Item code	Recommended quantity	Notes
1	C1 - C6	Spot-type fire detector	Optical smoke detector	ID100	2	ID100 is recommended, max. 6 pcs.
			Class A1R heat detector	ID200	2	
			Smoke and heat detector	ID300	2	
2	C1 - C6	Detector receptacle	Standard fire detector receptacle	EB0010	2	Qty = detector qty
3	ROP	Manual call point	Standard manual call point	ROP OP1	1	max. 10 pcs.
4	S1, S2	Fire alarm indicator	Fire alarm sounder, low base	SPP-100	1	max. current 200 mA
5	M	Electric drive	internal (tubular)	VIC-042x	1	
6	PKzM	panel	elevated control panel	PKzM	1	
7	MM-S	Control unit	controller for 230 V AC drives with inverter	MM-S	1	for drives with a power of < 600 W or 600 > P > 1500 W

 MAŁKOWSKI MARTECH Czołowo, ul. Leśna 57, 62-035 Kórnik tel. +48 61 222 75 00 fax: +48 61 222 75 01 email: biuro@malkowski.pl, www.malkowski.pl	FIRE PROTECTION CURTAIN type: MARC-Ok E1120	Ref. no.: ISOiK_Ok-1
	USE, OPERATION AND MAINTENANCE MANUAL	Revision: 12 / 2021

7. TROUBLESHOOTING

Every failure of the fire protection curtain shall be reported to the manufacturer and removed by authorized personnel strictly as instructed by the manufacturer (ref. Section 8 INSPECTION, MAINTENANCE, AND REPAIRS).

Fault type	Causes of fault / operating error	Method of rectifying the fault by the operator
Curtain sheet does not unwind, drive motor is running	Guide rails obstructed or damaged	Call the Technical Service to clear or replace the guide rails
	Mechanical failure of a structural element Mechanical failure of the drive	Call the Technical Service to repair or replace the failed part(s)
	Extended load profile from the curtain sheet	Insert load profile into the groove of the curtain sheet
Drive motor does not start	No power, power off	Check key switch positions, turn to "I" ON position
	Battery discharged	Charge the battery
	Electricity supply fuse blown	Replace the fuse
Fire detector inoperative / fails to trigger the control system	Dirty or damaged	Call the Technical Service to clean, readjust, or replace the part(s)
Fire alarm sounder/beacon fails to come on		
Local control system (control unit) displays an error		System component failure
Manual call point does not work / has failed	MCP glass broken	Call the Technical Service to replace the part(s)

8. INSPECTION, MAINTENANCE, AND REPAIRS

8.1 INSPECTION & MAINTENANCE SCHEDULE

The fire door shall be inspected, maintained and repaired by personnel with sufficient qualifications and professional experience for these tasks.

The fire door manufacturer or its authorized installation contractors (ref. the guidelines in Section 1 INTRODUCTION and Section 2.4 SERVICE PERSONNEL REQUIREMENTS in this Manual) provide paid service inspections, maintenance, repairs, and troubleshooting according to the specific sales contract. This personnel have the required technical resources, spare parts, and qualifications.

Send your service requests for these tasks to the MAŁKOWSKI-MARTECH S.A. Technical Service, (serwis@malkowski.pl or fax: + 48 61 22 27 501). The Technical Service contact details are also on the manufacturer's official website and in the Warranty Certificate.

The inspections and maintenance must be done in compliance with this Manual (ref. the guidelines in the schedule tables below) to ensure correct and safe operation; they are prerequisite to maintain the declared performance of the overhead fire door and during the warranty period, otherwise the warranty rights and liability will be made void.

Inspection type	Frequency	Ownership
Pre-operation inspection	Before each use (does not apply to a fire emergency)	Operator



 MAŁKOWSKI MARTECH Czołowo, ul. Leśna 57, 62-035 Kórnik tel. +48 61 222 75 00 fax: +48 61 222 75 01 email: biuro@malkowski.pl, www.malkowski.pl	FIRE PROTECTION CURTAIN type: MARC-Ok E120	Ref. no.: ISOiK_Ok-1
	USE, OPERATION AND MAINTENANCE MANUAL	Revision: 12 / 2021

Monthly inspection	Every 1 month	
Service inspection and maintenance	Every 6 months	Authorized technical service

S – Check, inspect, clean; **X** – Adjust and lubricate

Inspection & maintenance schedule

Assembly / component	Tasks required	Before each use	Every 1 month	Every 6 months
Whole product				
Product structure	Check the painted surfaces (for dirt, etc.) and clean as required.		S	S
	Check that no part is missing and there is no evidence of damage of failure from operation.	S	S	S
	Check the product's identification markings (the nameplate must be present and legible).		S	S
Curtain sheet	Check for dirt, damage, etc.; clean as required.	S	S	S
	Check the position and attachment of the load profile		S	S
Brackets, guards, fascias	Check the fasteners and their condition			S
Winding up / winding down system of the door curtain				
Guide rails	Check the fasteners and their condition; look for obstructions			S
Masking gaskets	Check the fasteners and their condition, lubricate as needed ¹⁾			S
	Check for damage, cracks		S	S
Electrical / control system				
All electrical accessories	Trigger the sensors/detectors to test for proper operation of the accessories kit; readjust as required.			SX
Fire detector	Check the condition and clean the component; readjust as required.			SX
Manual call point	Check the condition and test the operation.			S
Control unit (panel)	Test the operation of all control panel components			S
	Check for error displays.	S	S	S
Key switch	Check the condition and test the operation.		S	S
Electric drive motor	Check the condition and test the operation (the component must run smoothly and without stuttering, audible noise, and evident vibration).		S	S
Battery pack	Inspect the terminals and wiring; clean and lubricate as required ¹⁾		S	SX
	Check the battery acid level and state of charge; refill with battery acid and recharge as required.		S	S
Electrical wiring system ²⁾	Inspect the fastening and condition of fittings and cable trays.		S	S

1) – petroleum jelly is recommended

2) – power wiring insulation resistance tests and wiring continuity tests are to be done at least every 5 years

Worn parts of the fire protection curtain type MARC-Ok and damaged parts must be replaced with new parts. Maintain and repair with genuine components and parts which are approved by the fire door manufacturer. Each inspection, maintenance, and repair shall be completed and certified by the authorized personnel according to the scheduled scope in the Periodic Inspection and Maintenance Log (appended to this Manual



 MAŁKOWSKI MARTECH Czołowo, ul. Leśna 57, 62-035 Kórnik tel. +48 61 222 75 00 fax: +48 61 222 75 01 email: biuro@malkowski.pl, www.malkowski.pl	FIRE PROTECTION CURTAIN type: MARC-Ok E120	Ref. no.: ISOiK_Ok-1
	USE, OPERATION AND MAINTENANCE MANUAL	Revision: 12 / 2021

in section 11 – APPENDICES) or in a separate certificate.

The fire door user shall retain all records of inspections, maintenance, repairs, and overhauls.

8.2 OPERATOR’S INSPECTIONS

The operator’s inspections shall be done by the operator assigned by the product’s user and trained by the fire door manufacturer or its authorized installation contractor (ref. also the guidelines in Section 2.4 SERVICE PERSONNEL REQUIREMENTS and Section 8.1 INSPECTION & MAINTENANCE SCHEDULE).

Wear basic PPE (personal protection equipment) e.g. rubber gloves etc. during each inspection service.

If the fire door fails, is damaged, or found to operate incorrectly, notify the site supervisors and the manufacturer or its authorized installation contractor.

8.3 SERVICE INSPECTIONS & MAINTENANCE

The technical services of the manufacturer are provided by qualified and professionally experienced service technicians of MAŁKOWSKI-MARTECH S.A. or its contractors who are authorized for servicing the fire door.

To verify for the buyer that the service is provided by a fully professional/authorized contractor or technician, the latter should hold and present their Installation Authorization Certificate, while the service technicians should hold and present their Site Authorized Service Certificate issued by the fire door manufacturer, MAŁKOWSKI-MARTECH S.A.

In the Lists of Components and Parts, ref. Section 6 TECHNICAL SPECIFICATIONS of this Manual, the fire door manufacturer specifies the ownership and right of repair/replacement of components, assemblies, and parts; failure in compliance to these specifications will void the product warranty and declaration of performance.

CAUTION!

Pursuant to the Polish Regulation ref. Dz.U.2010.109.719, as amended: §3.2 “Fire protection equipment (...) shall be technically inspected and maintained in compliance with the procedures and methods established in the Polish Standards [PN] concerning fire protection equipment and fire extinguishers, the equipment’s operating and maintenance manuals, and the user manuals issued by the respective equipment manufacturers.” §3.3 “Technical inspections and maintenance shall be carried out with the frequency established by the respective manufacturer and at least once a year.”

The service inspections, maintenance, repairs, and overhaul of the fire door shall only be done by trained personnel of the manufacturer or its authorized service contractor.

The fire door user or the personnel or contractor it has authorized is liable for collection and retention of documented proof that the service inspections and maintenance are carried out at least every six months, unless specified otherwise in the sale contract (or special requirements/site conditions of the user require other frequency of the service inspections and maintenance).

8.4 CLEANING

The operating personnel is required to keep the work place and the fire door clean. Clean with commercially available household cleaning products, e.g. dishwashing liquids.

Do not use aggressive cleaners or organic solvents, or pressure washing (with water or other liquids). If the fire door is contaminated with insoluble substances, remove them mechanically without damage to the sheet surface.

8.5 REPLACEMENT PARTS

Order the replacement parts by specifying the production year of the fire door, name, number and the quantity of parts.

ALL REPLACEMENT PARTS USED FOR INSPECTION, MAINTENANCE, REPAIRS, AND OVERHAULS SHALL BE GENUINE SPARE PARTS SPECIFIED BY THE MANUFACTURER IN THE LISTS OF COMPONENTS AND PARTS IN



 MAŁKOWSKI MARTECH Czołowo, ul. Leśna 57, 62-035 Kórnik tel. +48 61 222 75 00 fax: +48 61 222 75 01 email: biuro@malkowski.pl, www.malkowski.pl	FIRE PROTECTION CURTAIN type: MARC-Ok E120	Ref. no.: ISOiK_Ok-1
	USE, OPERATION AND MAINTENANCE MANUAL	Revision: 12 / 2021

SECTION 6 TECHNICAL SPECIFICATIONS OF THIS MANUAL.

9. DISPOSAL

Dispose of the fire door and all its worn out parts in compliance with applicable regulations of law. When the fire door or any of its parts reaches its end of life and requires dismantling and disposal:

- Remove the door components and electrical system by performing the assembly and installation in the reverse order, and follow by handing over the parts (like the electric motor) for waste recovery.
- Hand over all plastic, rubber, and mineral wool parts for disposal.
- Cut and scrap the steel structure, metal sheets, profiles, bars and other hardware with all other steel parts (including anchors, plugs, and bolts).

9.1 CHEMICAL NOTICE

None of the fire door components contains asbestos or coatings or elements which release any gases harmful to the ozone layer. The pigments and anti-corrosive treatment of the structure and components are free of cadmium, chromium and other air and soil aquifer layer pollutants.



 MAŁKOWSKI MARTECH Czołowo, ul. Leśna 57, 62-035 Kórnik tel. +48 61 222 75 00 fax: +48 61 222 75 01 email: biuro@malkowski.pl, www.malkowski.pl	FIRE PROTECTION CURTAIN type: MARC-Ok EI120	Ref. no.: ISOiK_Ok-1
	USE, OPERATION AND MAINTENANCE MANUAL	Revision: 12 / 2021

10. MARKING

Type MARC-Ok fire protection curtain is identified with the nameplate the specimen of which is shown below. The parameters of the delivered fire protection curtain are featured on the nameplate.



Fig. 13 – Specimen of the nameplate of the fire protection curtain (ref. EN 16034:2014-11)

The nameplate is located at the factory on the lower shaft housing, on the right-hand side next to the guide rail.

11. APPENDICES

- Periodic Inspection and Maintenance Log



 MAŁKOWSKI MARTECH Czołowo, ul. Leśna 57, 62-035 Kórnik tel. +48 61 222 75 00 fax: +48 61 222 75 01 email: biuro@malkowski.pl, www.malkowski.pl	FIRE PROTECTION CURTAIN type: MARC-Ok E120	Ref. no.: ISOiK_Ok-1
	USE, OPERATION AND MAINTENANCE MANUAL	Revision: 12 / 2021

- Warranty Certificate (SPECIMEN)
- Copy of the Declaration of Performance
- Available to the manufacturer-issued Installation Authorization Certificate holders:
 - VIC electrical accessories kit installation manual
 - Type MARC-Ok E120 fire protection curtain installation manual;



 MAŁKOWSKI MARTECH Czołowo, ul. Leśna 57, 62-035 Kórnik tel. +48 61 222 75 00 fax: +48 61 222 75 01 email: biuro@malkowski.pl, www.malkowski.pl	FIRE PROTECTION CURTAIN type: MARC-Ok E1120	Ref. no.: ISOiK_Ok-1
	USE, OPERATION AND MAINTENANCE MANUAL	Revision: 12 / 2021

PERIODIC INSPECTION AND MAINTENANCE LOG

Equipment type:	Serial number:	Year of production:
-----------------	----------------	---------------------

#	Completed servicing	Date & authorized stamp and signature	Notes
1			
2			
3			
4			
6			
7			
8			
9			
10			
11			
12			
13			
14			
15			
16			
17			
18			
19			
20			



 MAŁKOWSKI MARTECH Czołowo, ul. Leśna 57, 62-035 Kórnik tel. +48 61 222 75 00 fax: +48 61 222 75 01 email: biuro@malkowski.pl, www.malkowski.pl	FIRE PROTECTION CURTAIN type: MARC-Ok E120	Ref. no.: ISOiK_Ok-1
	USE, OPERATION AND MAINTENANCE MANUAL	Revision: 12 / 2021

WARRANTY CERTIFICATE

Warranty issued to the Buyer / Warranty Rights Owner*:		Installation location*:		
Warranty period*:		Ref. Contract/P.O. No.*:		
#	Sold product	Additional description*:	Identification no.*:	Quantity (pcs)*:
1	Fire protection curtain MARC-Ok E120	E120		
2	Local control system (control panel)	CSP M-M		
3	Fire detector, thermal	ID100		
4	Manual call point	ROP OP01		
5	Alarm sounder & beacon	SPP-100		

§ 1

Shipping; acceptance; pre-installation work

1. The quantity acceptance of the product is done prior to outbound shipping and at the site of MAŁKOWSKI-MARTECH S.A. (hereinafter, the GUARANTOR). The signature of the Installer/Buyer on the Goods Issue Note provided with the sold product certifies that the product is complete and conforms with the specifications in the Goods Issue Note.
2. Before the product is assembled/installed, the Installer shall carefully verify that the product has not been damaged in transport, remains of full value, and conforms to the purchase order submitted by the Buyer. If the product is found not to be conformity with the purchase order and/or any defect is found in the product, do not proceed with the assembly and installation process; immediately notify the Guarantor.
3. If the product's defect(s) could have been reasonably found with due diligence prior to the assembly and installation process, all WARRANTY CLAIMS for the defect(s) submitted once the product is assembled and installed will be rejected without examination.

§ 2

General warranty terms and conditions

1. The Warranty Rights Owner will retain its warranty rights provided that:
 - a) The sold product is assembled and installed by the Guarantor or a contractor who holds the Installation Authorization Certificate (issued by the Guarantor), and the assembly and installation process is certified with the relevant entry on the last page of this Warranty Certificate;
 - b) Periodic service inspections are ordered (pursuant to a separate service contract) for the product under this Warranty and to be performed by the Guarantor or the (manufacturer's) Service Authorization Certificate holder according to this schedule:
 - Every 6 months- when the product remains in its fully closed or open position without cyclic operation;
 - Every 3 months – when the product is operated in any way different than above and in compliance with the criteria established by the Guarantor in the service contract;
2. These warranty terms and conditions apply to the product sold by the Guarantor and purchased, assembled, and installed in the Republic of Poland.
3. The service inspections specified in § 2.1 above are payable.
4. Within 14 days after each service inspection completed by the Service Authorization Certificate holder, the Warranty Rights Owner shall provide the copies of the service inspection certificates to the Guarantor:
 - a) by e-mail at serwis@malkowski.pl, and
 - b) to the Guarantor's registered office address, or the warranty rights will be made void.
5. The warranty period begins on the date of certified post-assembly and installation acceptance of the product.
6. The rights granted under this Warranty do not include the right to claim damages for lost profits or compensation for



any damage related to the failure of the product, except for the rights granted under this Warranty.

§ 3

Procedure of warranty claims and exercise of warranty rights

1. The Warranty Rights Owner is required to report each defect discovered in the product, which shall be done in writing and in 14 days after the discovery.
2. Each warranty claim shall be submitted to the Guarantor in writing or be null and void.
3. The claim should include:
 - a) a copy of the Warranty Sheet,
 - b) A detailed account of the discovered defects, its causes, and conditions in which they have emerged;
 - c) The product serial number;
 - d) Proof of completion of the periodic service inspections of the product as specified in § 2.4.
4. To ensure smooth warranty claim processing, it is recommended to attach photographic evidence of the defective product to facilitate examination.
5. The Warranty Rights Owner shall provide all conditions required for and facilitating repair of the claimed product (especially by permitting access to the product and removal from service of all equipment which can be hazardous to the personnel removing the claimed defects).
6. Failure to submit a warranty claim by the time specified in § 3.1 will release the Guarantor from the obligation of processing the warranty claim.

§ 4

Warranty rights

1. If the warranty claim made under the Warranty is reasonable, the Guarantor shall, at its own discretion, remove the defects of the product (by repairing it) or replace the product (or its affected part) with a new counterpart.
2. The title of the replaced defective products will become property of the Guarantor.
3. If defects or failures are discovered during the warranty period and prevent use of the product, the Guarantor shall act as reasonably required to remove the defects or failures in 10 business days from the date of claim.
4. If defects or failures are discovered during the warranty period and DO NOT prevent use of the product, the Guarantor shall act as reasonably required to remove the defects or failures in 20 business days from the date of claim.
5. The time limits specified in § 4.3 and § 4.4 can be extended due to reasonably important causes, especially whenever:
 - a) the parts necessary for the execution of the warranty rights are not available on the market;
 - b) it is necessary to import some or all parts from abroad to process the warranty claim;
 - c) reasons beyond any control of the Guarantor arise, of which the Warranty Rights Holder will be advised.
6. Working days are understood as days from Monday to Friday, excluding holidays and public holidays.
7. If, in the performance of its obligations, the Guarantor supplies the Warranty Rights Holder with an item free of defects instead of a defective item, or has made significant repairs of an item on warranty, the warranty period for the item shall run again from the date of delivery of the item free of defects or the return of the repaired item to the Warranty Rights Holder.
8. The warranty for the replaced items shall start again from the date of delivery of the item free of defects or repaired, with respect to the replaced item.
9. The replacement of parts/items shall not result in extension of the warranty period for the whole product sold.
10. The Guarantor is entitled to charge the Warranty Rights Holder with the costs of an unreasonable warranty claim (which is unreasonable if the claimed defect does not exist or the claim features a request for remedying a defect not covered by this Warranty).
11. The costs referred to in § 4.10 specifically include the costs of service travel to the product's site and the costs of removal of the defects, if any.
12. The costs of defect removal not covered by this Warranty will be evaluated according to the price list of the Guarantor.

§ 5

Exclusion of warranty rights

The Warranty does not cover:

1. Defects caused by reasons other than those inherent in the object of sale,
2. defects caused by any tampering with the sold product by the Warranty Rights Owner or a third party, especially alterations and modifications without prior written authorisation of the Guarantor; if the sold product is tampered with, the WARRANTY AND THE DECLARATION OF PERFORMANCE ARE VOID;
3. defects caused by misuse / non-intended use of the product or failure in routine maintenance of the product, especially any use or maintenance in deviation from the manuals of the product to which this Warranty Certificate is attached;
4. defects resulting from assembly or repairs performed by personnel not authorized by the Guarantor;
5. the product installed on a site under this Warranty with failure to provide service inspections by the Guarantor or the Service Authorisation Certificate;
6. parts of the product which are naturally worn, partially or completely, according to the properties or the intended use (these include running assembly parts, electrical batteries, etc.);
7. mechanical damage of the product and the defects resulting from it;
8. defects caused by defects of the structure in which the product has been installed;
9. incorrect selection of the product to the conditions at the installation site;
10. defective operation of the installed equipment which has not been provided by the Guarantor, and resulting in negative impact on the product. Should any of the foregoing occur, THE DECLARATION OF PERFORMANCE ISSUED FOR THE PRODUCT AND ITS WARRANTY CERTIFICATE ARE AUTOMATICALLY VOID AND NULL;
11. defects resulting from the external factors, especially fire, extreme weather, and fortuitous event;
12. damage caused by misuse of the product or its operation in deviation from the operating manuals, which also includes operation beyond the maximum performance limits;
13. use of non-genuine spare parts, which are parts not original to the Guarantor;
14. the product sold if this Warranty Certificate is redacted or defaced in any way;
15. the product sold if its nameplate is removed, damaged, or modified;
16. the product with its warranty seal is damaged or removed.

.....
Date and signature of the Guarantor's Installation Authorisation Certificate Holder

.....
Authorization no. and date of issue